

# X-PACK 18 Operation Manual

(Suitable for wide indoor environments operation and wind power less than Force 2 outdoor environments)

Suitable for 14 years old and above

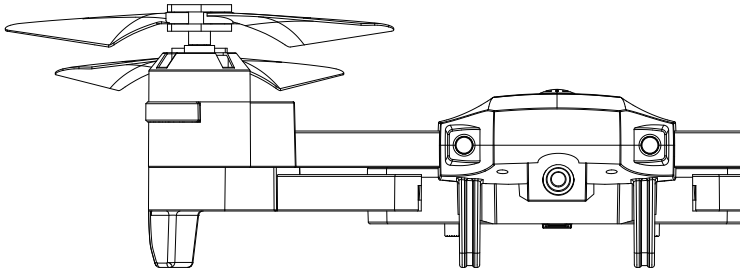

Get 24/7 assistance at



Use camera or QR scanner to scan  
Or Visit: <https://attop.afterservice.vip>

[www.attoptoy.com](http://www.attoptoy.com)

Customer Service Email : [support@attoptoy.com](mailto:support@attoptoy.com)

## 1. Package Contents

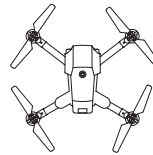

Drone X1

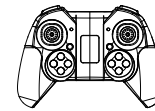

Remote X1



Backup Propellers X4

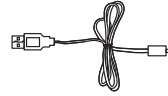

USB cable X1



Battery X2



Screw driver X1

## 2. Charging

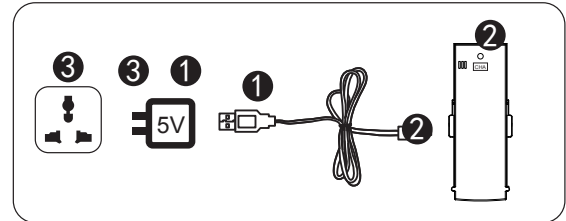

### Low battery warning

When the drone is flying, the indicator lights on the drone are flashing, and the remote control handle emits a "beep" alarm sound, indicating that the drone power is too low. At this time, the drone needs to return and charge.

### Charging Guide for battery

1. Connect the USB cable with power supply, the USB LED solid on, indicate the USB cable is power on.
2. Connect the battery with USB cable. If the USB LED solid on, the charging is completed. Otherwise, it means charging. Please use the drone when fully charged.



Note: Use an power supply with standard output voltage 5V and current greater than or equal to 2A, otherwise there is a risk of overloading the USB cable and Battery. The flight time is about 9-10 minutes and the charging time is about 120 minutes.

1

## 3. Install

(1) Open Up all 4 blades for the drone

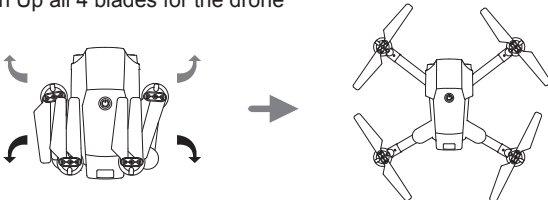

This aircraft is folding structure, please do open up all four propellers before taking off.

(2) Battery Installing

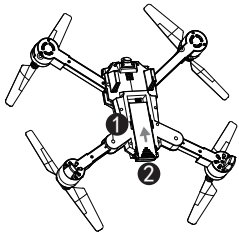

Remote Controller:

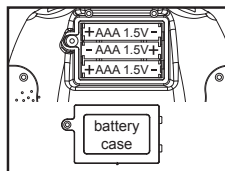

Insert 3xAAA battery into specified position.

1. Insert the battery into specified position.
2. To disassembly, press the battery buckle button, and pull back to take it out.

(3) Mobile Device Holder Using

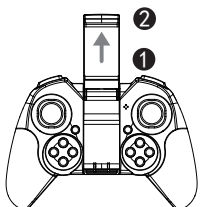

1. Pull up the position of controller.
2. Adjust the Mobile Device Holder up and place the mobile onto the holder.

2

## 4. Remote Controller

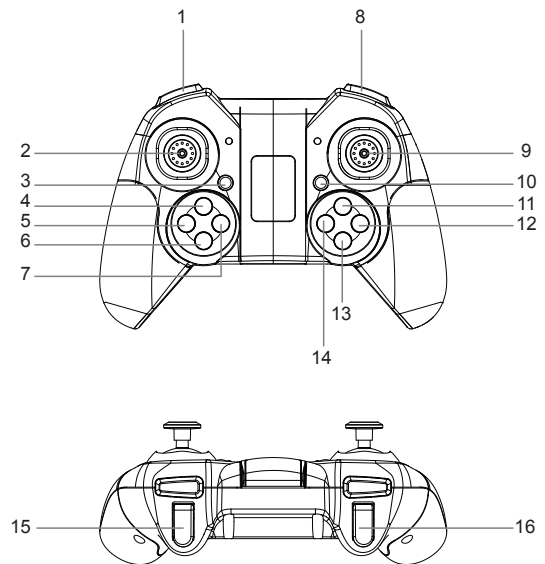

- |   |                                   |
|---|-----------------------------------|
| 1. Speed switch                             | 9. Right stick (Movement control) |
| 2. Left stick (Altitude Control / Turn L/R) | 10. Gyro calibration              |
| 3. Power switch                             | 11. Forward trimming              |
| 4. One key take off                         | 12. Right trimming                |
| 5. Circle fly                               | 13. Backward trimming             |
| 6. One key landing                          | 14. Left trimming                 |
| 7. One key return                           | 15. Filming                       |
| 8. Headless function                        | 16. Take Photo                    |

3

## 5. How To Fly

### (1) Switch On the Power

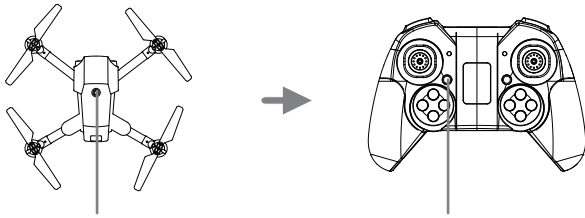

1 First power on the drone (Keep pressing for 2-sec and place it on a flat ground or surface.)

2 Power on the Remote

### (2) Frequency pairing

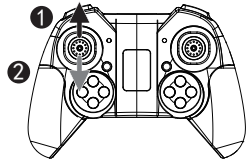

After powered on the drone, both indicator lights on the drone and controller are flashing. Push the Left stick to the top, and then down to the lowest, after 2 secs, the indicators will go steady, that means the frequency paired successfully.

### (3) Gyroscope calibration

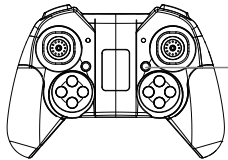

Press the Calibration button for the gyro calibration. (For the aircraft fly more stable if operate this step before activate motors everytime).

4

### (4) Activate motors for taking-off

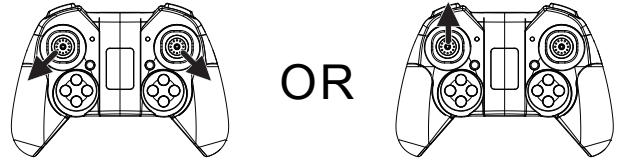

Push the Left stick to the lowest left corner, and meanwhile push the right stick to the lowest right corner, (Or just push the left stick to the top) then the motors of the drone start rotating.

### (5) Take off / Landing

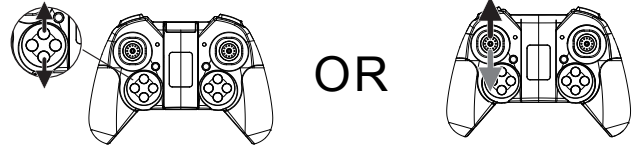

After activated the motors, press "One key take off" (or push up the Left stick directly) to fly. Press "One key landing" (or keep pushing down the Left stick directly) to land.

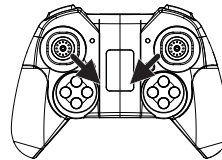

### Emergency Stop

In case of emergency status, push the Left stick to the right corner, meanwhile push the Right stick to the left corner at the same time, the drone will immediately stop and drop off.

5

## 6. Using the Remote Controller

Left Stick

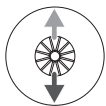

Ascend / Descend

Right Stick

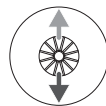

Forward / Backward

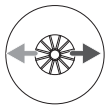
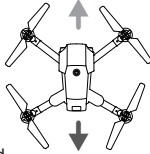
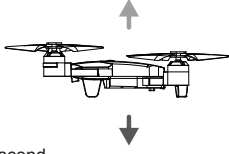

Turn left / Turn Right

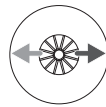
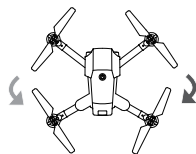

Left-side Fly / Right-side Fly

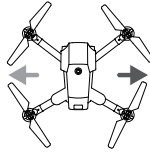

## 7. Aircraft Functions

### TRIMMING ON THE FLYING ACTIONS



trimmer (forward/backward)

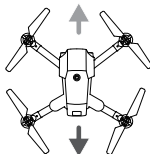

Adjustment for deviated flying to Front/Backward  
If it leans forward, press the down trimmer.  
If it leans backward, press the up trimmer.

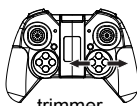

trimmer (sideward fly)

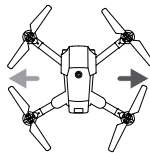

Adjustment for deviated flying to sideward  
If it leans left, press the right trimmer.  
If it leans right, press the left trimmer.

6

### 360° Flip Function

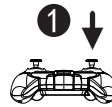

1. Short press the Right Stick



2. Push the stick to right, the drone will rotate 360° toward right direction

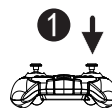
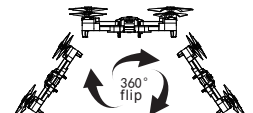

1. Short press the Right Stick



2. Push the stick to top, the drone will rotate 360° toward front direction.

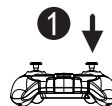
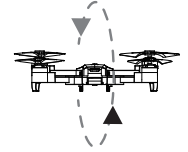

1. Short press the Right Stick



2. Push the stick to left, the drone will rotate 360° toward left direction.

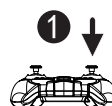
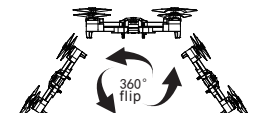

1. Short press the Right Stick



2. Push the stick to bottom, the drone will rotate 360° toward back direction.

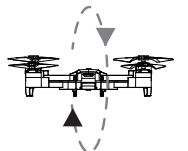

7

### Speed Adjustment

Speed ±

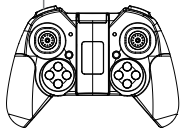

The drone is set to low speed by default. Press the Speed button to change the speed gear while flying. There is 3 gears, each gear has a "beep" notice voice, the default speed is the most slowly one, when press one time you will hear "beep beep", then go into the second speed gear, and press again with "beep beep beep" to the final fastest speed.

**Remark: Beginners would be suggested to use the default speed firstly to play until skillful.**

### Take photo / Filming

(13) Filming

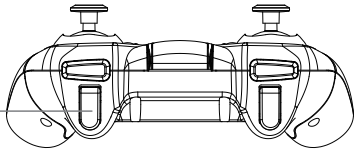

Press the Filming button to start and press again to finish and save the video. Please make sure to open the app on your smart phone before using it, then you can review the videos taken in the media file of app or in your mobile image file.

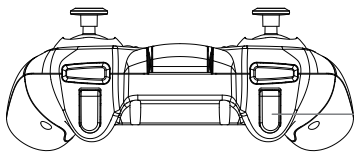

(14) Take Photo

Press Take photo button. Please make sure to open the app on your smart phone before using it, then you can review the photos taken in the media file of app or in your mobile image file.

**! Note : The Video and Take Photos switch only for WiFi version.**

## 8.Headless Mode Function

Press the Headless function button, when the indicator lights slowly flashing, means it is in Headless Mode. Press the Headless function button again, when the indicator lights stop flashing, means deactivate Headless Mode.

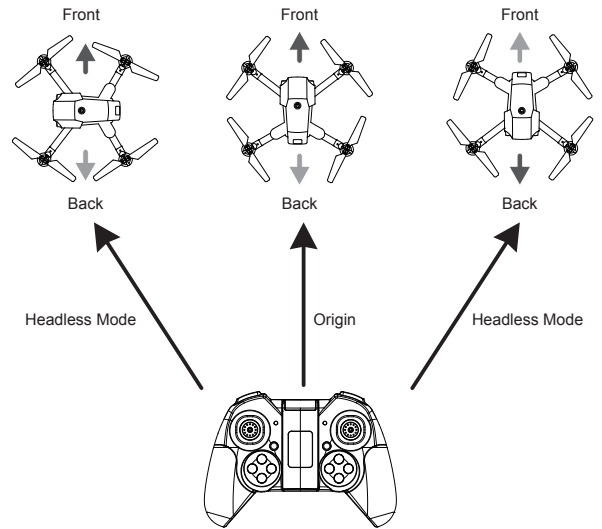

Users are recommended to stay same orientation as the drone head is facing when the drone takes off.

Under Headless Mode, the forward direction is the direction that the head of drone faces when the drone takes off.

In order to make sure the users can tell drone's direction, we suggest that users better to stay in the same orientation as the drone facing when it takes off.

Then no matter which direction the head is facing, the drone will lock the controlled direction as the remote controller, easy to control back the drone.

## 9.One key return

The remote toward the tail of drone and press the button, then the drone will fly toward its back following a path parallel to remote direction. The LEDs on the drone keep flashing when the drone is returning.

Press the button again or move the Right Control Stick, forward to cancel this function, or the drone will keep flying back.

**! Note: Please deactivate Headless function and make sure the remote toward the tail of drone before activate the Return function.**

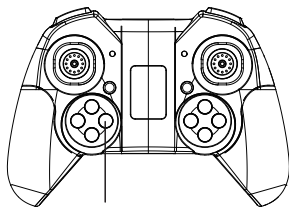

One Key Return

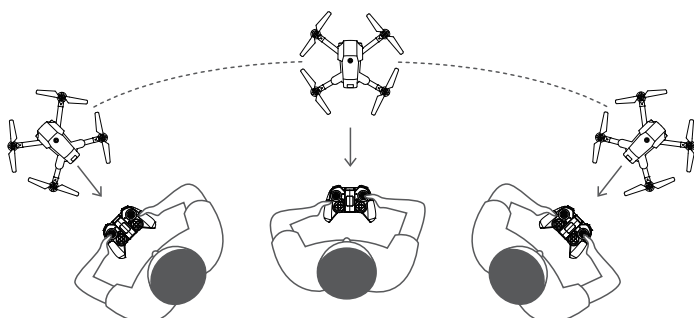

## 10.Aircraft Parameters

Length of main wing:	152mm
Aircraft:	190X226X73mm
Total weight:	148g±2g
Battery:	3.7V 1100mAh
Charging time:	About 120 mins
Flight time:	9-10 mins
Gyroscope:	built-in
Working temperature:	-10°C to 40°C
Remoter controller:	2.4G
Motor:	85X20 4pcs

## Camera Parameters

TF card support:	NO
Camera Lens:	1080P

## Remote Controller Parameters

Wifi Transmission Range : 60-80 meters  
(in a wide open area with no electromagnetic interference)

Working frequency:	2.4G
Battery:	3xAAA

## 11. FAQ

	ISSUES	CAUSE	SUGGESTIONS
1	After the battery is inserted in the drone, indicator lights on drone keep flashing, no response to operations	Frequency matching between remote and receiver not successful	Reoperate the frequency matching for remote and drone (please refer to P.4 for details)
2	No response after battery is inserted in the drone	1. Check if the power for remote and drone is full charged. 2. Connection of the poles are not good	1. Open the remote battery case and make sure if the battery is inserted in right position 2. Use a fully charged battery 3. Reinstall the battery and confirm whether it is good connecting with the poles well.
3	Motor does not run when operating the throttle stick and the indicator lights on drone keep flashing	Power for the Li-Poly battery is not enough	Charge the battery or replace it with a full-charged battery
4	Main motor blades spin but the drone won't fly	1. Some of the blades have been deformed 2. Battery power is not enough	1. Replace the main blade 2. Charge the battery or replace it with a fully charged battery

12

## 12. Battery Using Attention

### Matters needing attention









- Rechargeable batteries are to be removed from the toy before being charged.
- Non-rechargeable batteries are not to be recharged.
- Rechargeable batteries are not to be charged under adult supervision.
- Only used to charging 2S Li-ion or Li-polymer battery pack. If not, the charger or battery may be damaged.
- During charging, the charger should be put in dry and ventilated place and far away from heat source and inflammable and explosive substance.
- Never immediately charge your battery pack as soon as the flight is finished, or when its temperature doesn't cool down. Otherwise the battery will take a risk in swelling, even a fire.
- Ensure the correctness of polarity before connection the battery to charger.
- Avoid drop and violence during the process of charging. drop and violence will result in internal short circuit of the battery.
- For the sake of safety, please use original charging equipment and battery pack. please change new one in time when the flying time is becoming shorten due to long time usage.
- If it is retained in the charger for a long time after saturated, the battery may automatically discharge. When the charger detects that the voltage of individual cells is lower than the rated voltage, it will re-charge until saturated. Frequently charging and discharging will shorten the lifetime of your battery pack. It is advised that please cut off the power and took off the battery after the charging is saturated.

### Maintenance of battery pack

- The battery pack should be put in dry and ventilated place. The storage temperature of environment is ranged from 18°C to 25°C.
- Please avoid frequent charging and excessive discharging the battery pack in order to prolong its life cycle.
- It is a must to maintain the battery pack before long-term storage. That is to charge the battery to the level of 50-60% saturation.
- If the storage term is over 1 month, it is advised to monthly check the voltage of every cell of the battery pack. The voltage of every cell should be not less than 3V. Otherwise, please refer to the above article (3).
- From the view point of protection, new battery pack should be motivated before usage. That is to charge and discharge 3-5 times, but discharge is not less than the level of 70% saturation. This process will make the battery lifetime longer and voltage more stable.

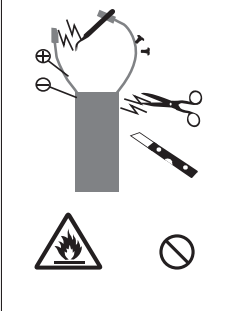
13

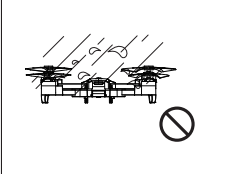
## SAFETY AND PRECAUTIONS

	Remote-control models of quadcopter are dangerous merchandise. Their flight must be operated away from the crowd. Such factors as man-made improper assembly or mechanical damage, poor control of the electronic equipment, as well as the unfamiliar manipulation may lead to unexpected flight accidents, such as uncontrolled flight and aircraft damage. Users are advised to pay attention to the flight safety and understand that they are held responsible for any accident caused by negligence.	
	Special drone for Indoor and outdoor should stay away from barriers	
	Safe usage of the lithium battery	
	Away from moist environments	
	Never misuse the product	

14

### Safe usage of the battery

Batteries are to be inserted with the correct polarity. The supply terminals are not to be short-circuited. Different types of batteries or new and used batteries are not to be mixed. The exhausted batteries are to be removed from the toy. For long time storage, please take them out to prevent battery leakage. Please dispose abandoned batteries in accordance to the laws and regulations of the corresponding region to prevent pollution to the environment.



### Keep away from source of heat

The aircraft is mostly made of PA fiber or polyethylene as well as other main materials for electronic products. Therefore, it must be kept from the source of heat and exposure to sunlight so as to avoid possible damage of deformation or even meltdown due to high temperatures.



### Never operate the product alone

This product is suitable for users over 14 years old. Since the remote-control quadcopter may pose a certain degree of difficulty for learners at the beginning, it is recommended for it to be operated under the guidance of experienced people for the sake of safe flight.



## 13. Disclaimer

Please read this manual carefully before using our product. This product is not recommended for people under the age of 14. By using this product, you hereby agree to this disclaimer and signify that you have read it fully. You agree that you are responsible for your own conduct and any damage caused while using this product, and its consequences. You agree to use this product only for purposes that are proper and in accordance with local regulations, terms and all applicable polices and guidelines ATTOP may make available.

15

## Description of ATTOP GO drone WIFI Version

This version of drone comes with the WIFI Live Stream Camera.



SCAN,AND DOWNLOAD APP

### How to connect the WIFI Signal

- 1, Download the app "ATTOP CLUB  " from App Store / Google Play.
- 2, Power on the drone.
- 3, Go to the WIFI setting on phone/device, choose the WIFI signal of the drone (X-PACK 18+No.) , and connect it.
- 4, Now open the app of the drone, and Slip to Select The Drone "X-PACK 18" then enjoy to play it.

**!** Attention: When the drone is at the statue of low battery, it might unable to be connected successfully.

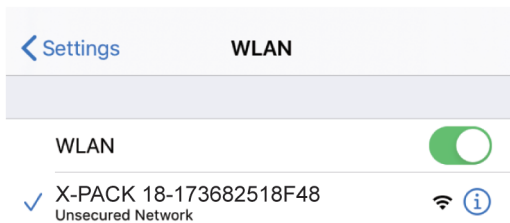

16



- 1 Ascend / Descend / Turn left / Turn right
- 2 Go forward / Go backward / Left side flying / Right side flying
- 3 Gesture control
- 4 Music
- 5 Speed mode: 30%,60%,100%
- 6 360° flip
- 7 Headless mode
- 8 Gravity Control (press it to perform this function, by changing your action of shaking device to control the drone flying)
- 9 Flight path mode
- 10 Voice control
- 11 VR mode
- 12 Return home page
- 13 On/Off for control interface
- 14 Switch to take video
- 15 Switch to take photo
- 16 Go Forward / Backward trimmer
- 17 Left / Right side flying trimmer
- 18 EMERGENCY STOP !!!
- 19 One key take off
- 20 One key landing
- 21 Calibration

18

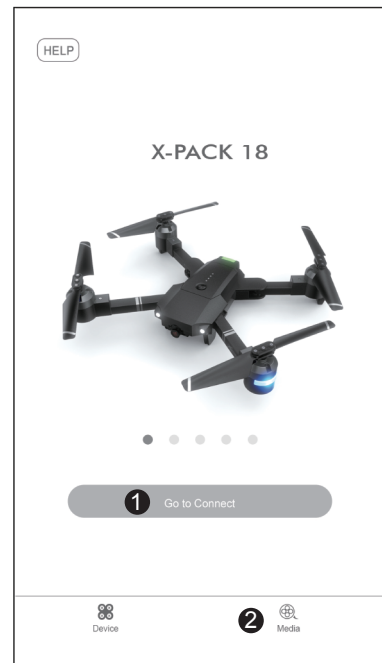

After connecting the WIFI signal between the drone and mobile device, and open the APP, we can Slip to Select The Drone "X-PACK 18" see the screen as image above.

- 1 Enter to the Interface of this drone after selection.
- 2 Media Folder : After taking photos and videos, you can review them from this folder.

17

### Ready to fly

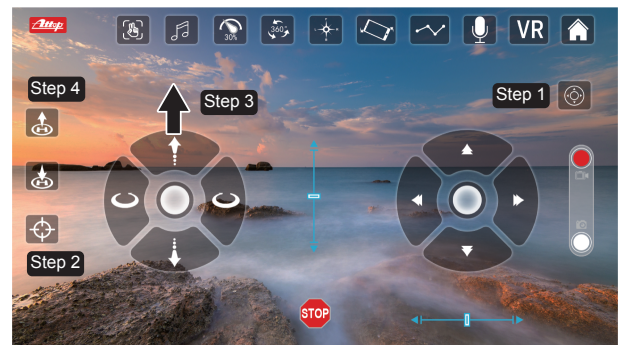

pic 1

- 1 After connecting the WIFI signal and enter into the operation interface, press the "ON/OFF button" to open the sticks.
- 2 Wait for 2 seconds till the lights of the drone stop flashing then press the "Calibration button" to calibrate the drone if first time play.
- 3 Push the Left Control Stick to the top and then release. Now the rotors of the drone start rotating, that activate the motors. (see pic 1)
- 4 Press the "One Key Take Off " to fly up the drone (or push up the Left Control Stick slowly), to take off. Press the "One Key Landing" (or keep pushing down the Left Control Stick directly) to land the drone.

19

## APP operation method

- ① Ascend / Descend / Turn left / Turn right
- ② Go forward / Go backward / Left side flying / Right side flying
- ③ Gesture control
- ④ Music
- ⑤ Speed mode: 30%,60%,100%
- ⑥ 360° flip
- ⑦ Headless mode
- ⑧ Gravity Control: Switch "Gavity Sense Mode" , wave the mobile phone as image showed below, the drone will move as same direction movement.

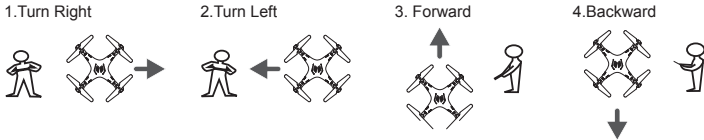

- ⑨ Flight path mode: Press  and you can draw a flying route plan on the screen, the drone will fly according to the route you designed.

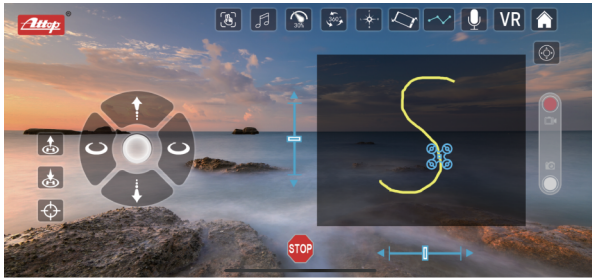

20

- ⑩ Voice control: Unlock the motors and the rotors of the drone start rotating, then press  and say "Take off" / "Landing" / "Forward" / "Backward" / "Left side" / "Right side" six voice instructions, the drone will reflect correspondent actions.

**!** Note: The APP needs your access allowance to use microphone,when first activate this function.

- ⑪ VR mode: Suitable for VR glasses using.
- ⑫ Return home page
- ⑬ On/Off for control interface
- ⑭ Switch to take video
- ⑮ Switch to take photo

After taking photos and videos, you can review them from Home page Media Folder or your album file of your mobile device.

**!** Note: The APP needs your access allowance to phone album, when first activate this function.

- ⑯ Go Forward / Backward trimmer
- ⑰ Left / Right side flying trimmer
- ⑱ EMERGENCY STOP:In case of an emergency, press  the drone will immediately stop functions and drop off.
- ⑲ One key take off
- ⑳ One key landing
- ㉑ Calibration

21

## 2, Control with the remote controller (IF your drone with controller)

- 1, Power on the drone and power on the remote, after pairing the frequency between the remote and drone (the lights of the drone and controller become permanent), then connect the WIFI signal between your device and the drone.
- 2, Put the device to the clamp of the remote controller, then go to the app interface to play the FPV flying.
- 3, Press the "Picture" button on interface or on controller, to take picture. Press the "Video" button on interface or on controller, to take video. After taking you can review the files from the media folder, or from your album file of your device.



### 30-Day Whole Unit Warranty For Quality-Related Issue

For 30 days after the date of purchase, we take care of all quality-related issues with a REPLACEMENT.

Reminder : Be sure to operate your drone as directed.

### 90-Day Accessories Warranty For Any Reason

For 90 days after the date of purchase, we take care of all accessories quality-related issues with an ACCESSORY REPLACEMENT.

Reminder: Be sure to maintain your drone as directed.

[www.attoptoys.com](http://www.attoptoys.com)

**Customer Service Email : support@attoptoys.com**

Name of App :  ATTOP CLUB

Apply to IOS \ Android system (Note: Apply to Android 2.3 or above such as SAMSUNG, SONY, HUAWEI and etc.

But cannot guarantee the phone of other brands with Android system could operate stably.)

22