

Fancyarn

Flute writing desk

Y17X01

Assembly Instructions





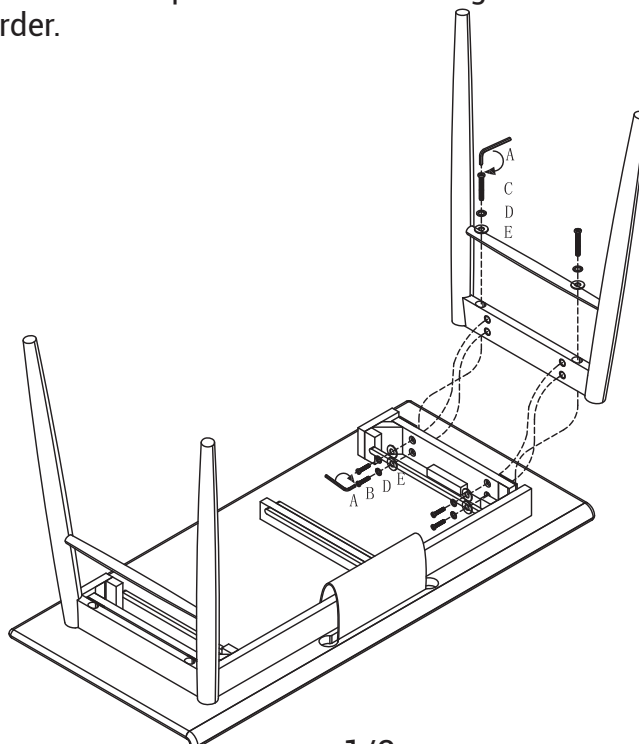

The assembly steps are as follows:

Step 1: Take out the drawers. Lay the desktop facedown on a flat, clean and non-abrasive surface. Attach the side frames to the desktop as shown in the diagram below. Make sure you fit the hardware together in the correct order.

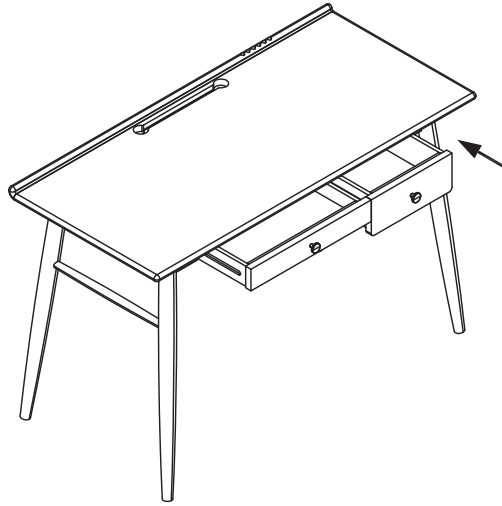

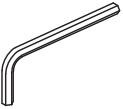
Step 2: Stand the assembled desk on the floor and replace the drawers.

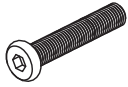

				
A. Allen key x 1	B. Socket cap screws (M8x35) x 8	C. Socket cap screws (M8x60) x 4	D. Split washers (ø8) x 12	E. Flat washers (ø8x14) x12

Contact Us

If you encounter any problems when using this product, please feel free to contact us through the following methods or scan the QR code to get a quick response and a satisfactory solution.

Amazon Platform: "Contact Seller"

Official Website: <https://fancyarn.afterservice.vip>

Email Address: fancyarn@afterservice.vip

Get 24/7 Assistance at



Or Visit: <https://fancyarn.afterservice.vip>