

Fancyarn

Rattan coffee table

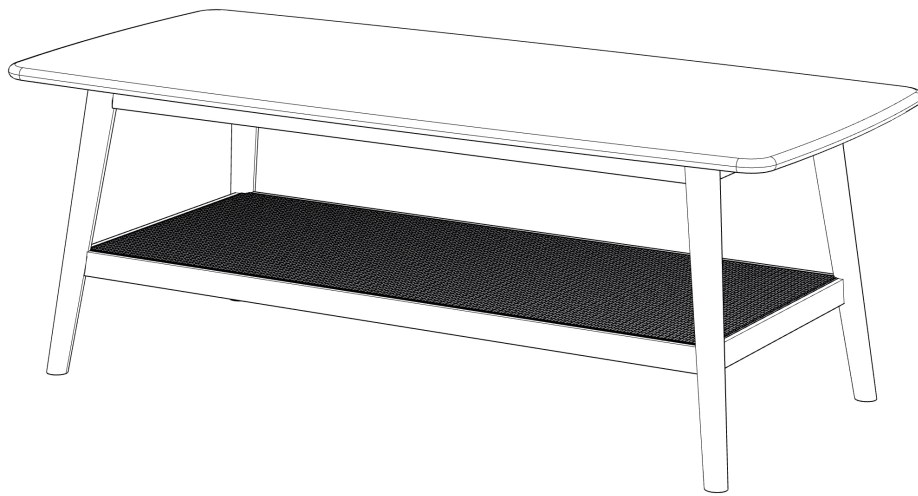



Y49J01

Assembly Instructions

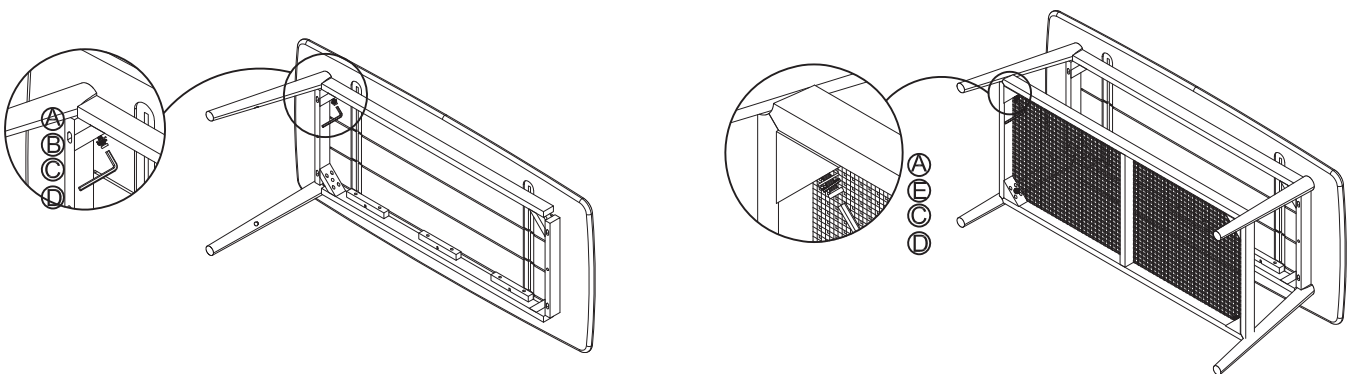

Lay the tabletop on a flat, clean and non-abrasive surface. As shown in the diagram below, attach the legs to the tabletop and then attach the rattan shelf to the legs, without fully tightening the screws. Finally, fully and securely tighten all the screws.



				
A. Allen key (5#) x 1	B. Screws (M8*65) x 4	C. Split washers (ø8*13) x 8	D. Flat washers (ø8*17) x 8	E. Screws (M8*75) x 4

Contact Us

If you encounter any problems when using this product, please feel free to contact us through the following methods or scan the QR code to get a quick response and a satisfactory solution.

Amazon Platform: "Contact Seller"

Official Website: <https://fancyarn.afterservice.vip>

Email Address: fancyarn@afterservice.vip

Get 24/7 Assistance at



Or Visit: <https://fancyarn.afterservice.vip>