

**14+**  
age

# W80 Instructions For Use

(Please keep and read this manual carefully before using this product.)

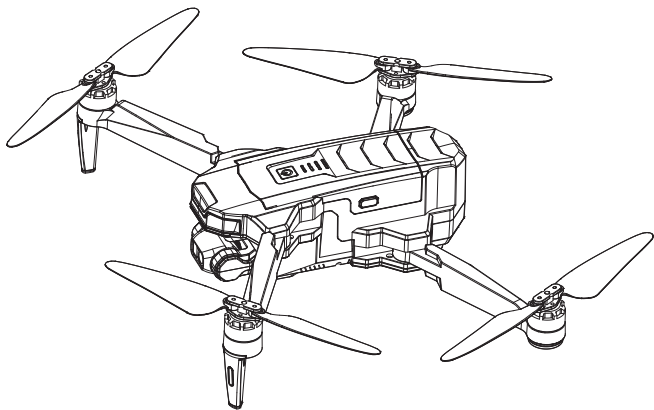

Get 24/7 assistance at



Use camera or QR scanner to scan  
Or Visit: <https://attop.afterservice.vip>

**[www.attoptoy.com](http://www.attoptoy.com)**

**Customer Service Email: [attop@afterservice.vip](mailto:attop@afterservice.vip)**

---

## **DISCLAIMER & WARNING**

1. Please read this Disclaimer & Warning and Safety Guidelines carefully before using our product. This product is not recommended for people under the age of 14. By using this product, you hereby agree to this disclaimer and signify that you have read it fully. You agree that you are responsible for your own conduct and any damage caused while using this product, and its consequences. You agree to use this product only for purposes that are proper and in accordance with local regulations, terms and all applicable policies and guidelines ATTOP may make available.

2. When using this product, please be sure to strictly abide by the specification requirements and safety guidelines stated in this document. Any personal injury property damage, legal disputes and all other adverse events caused by the violation of the safety instructions or due to any other factor, WILL NOT be ATTOP's responsibility.

## **SAFETY GUIDELINES**

### **Check Before Using:**

- ① This product is a high precision drone that integrates various electronic stability and control mechanisms. Please be sure to set up this drone carefully and correctly to ensure safe, accident-free operation.
- ② Please be sure that the batteries of the drone and controller are clean, undamaged and, fully charged.
- ③ Please be sure that all the propellers are undamaged and are installed in the correct orientation.

---

④ Please do a thorough check of the product before each use. Inspect the integrity of the parts, any signs of cracks and wear of the propeller, battery power and effectiveness of the indicator, etc. After doing a complete check, if any issue is found, please stop using the product until the issue has been solved.

### Flight Environment:



+



+



**Fly in Open Areas**

**Maintain Line of Sight**

**Fly Below  
390 feet (120 m)**



Avoid flying over or near obstacles, crowds, high voltage power lines, trees, South Pole and North Pole, base station.

DO NOT fly near strong electromagnetic sources such as power lines and base stations as it may affect the onboard compass.



Don't use this drone in adverse weather conditions such as rain, snow, fog, and wind.

---

## Operation Requirements:

- ① Please don't use this product to follow any moving vehicles.
- ② During the flight, only turn off the motor in case of an emergency.
- ③ As battery becomes low return the drone back to your starting point.
- ④ This product should not be used while drinking alcohol, if you are feeling fatigued, taking medicine, or feeling any physical discomfort.
- ⑤ Beware of the noise volume the drone produces. Keep your distance to avoid ear damage.



**⑥ Stay away from the rotating propellers and motors.**

**⑦ Don't fly in the No-Fly Zone.**

**⑧ Don't touch the Gimbal.**



## Use of Gimbal:

- ① The Gimbal is detecting rough 10 seconds after compass calibration. When the Gimbal indicator light is solid on, it indicates that the detection completes.
- ② Do not touch the Gimbal.
- ③ If the Gimbal getting stuck 5 times or more, it will be out of running and the Gimbal indicator light will be solid on. Please reboot the drone.

## Use of Battery:

- ① Please ensure batteries are fitted in the correct orientation as shown in the instruction manual.
- ② Avoid short circuits by fitting the batteries incorrectly, and do not crush or squeeze the batteries as this could carry the risk of an explosion.
- ③ Do not mix new and old batteries as this can lead to a poor performance of the product.







- 
- ④ Dispose of used batteries carefully. Do not litter.
  - ⑤ Please keep dead batteries away from heat and fire.
  - ⑥ If the device is not going to be used for an extended period of time, remove batteries to prevent potential damage from battery leakage.
  - ⑦ It is recommended to only use the USB charging cable that comes with the drone to charge the battery.
  - ⑧ Don't connect the battery directly to wall outlets or cigarette lighter sockets.
  - ⑨ Don't attempt to disassemble or modify the battery in any way.
  - ⑩ Don't use the battery if it gives off an odor, generates heat, becomes discolored, deformed, or appears abnormal in any way. If the battery is in use or being charged, remove it from the device or charger immediately and discontinue use.
  - ⑪ Don't pierce the battery casing with a nail or other sharp object, break it open with a hammer, or step on it!
  - ⑫ Always charge the batteries in a fireproof container and away from combustible materials. Don't charge the batteries on surfaces that can catch fire. This includes: wood, cloth, carpet, or in the application's device.
  - ⑬ Don't immerse the battery in water or allow it to get wet.
  - ⑭ Don't solder battery terminal directly.
  - ⑮ Keep the battery out of the reach of children or pets.
  - ⑯ Don't short-circuit the battery by connecting wires or other metal objects to the positive(+) and negative(-) terminals.

	<p><b>Li-Po Battery Disposal &amp; Recycling</b></p> <p>Waste Lithium-polymer batteries must not be placed with household trash. Please contact local environmental or waste agency or the waste agency or the supplier of your model or your nearest Li-Po battery recycling center.</p>	
---	---	---

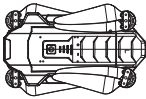
## MAINTENANCE

- ① Clean the product after each use with a clean, soft cloth.
- ② Avoid prolonged exposure to direct sunlight and avoid buildup of heat on the drone.
- ③ This device is not waterproof and must not be submerged in water under any circumstance. Failure to maintain the device completely dry will result in the failure of the unit.
- ④ Check the charging plug and other accessories for signs of damage frequently. If any part of the device is damaged, refrain from flying until maintenance can be carried out.

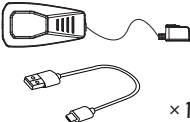
## PACKAGE CONTENTS

 ×1	 ×1	 ×2
Drone	Controller	Drone Battery
 ×8	 ×1	 ×1
Propeller	USB Charging Cable with Charge Hub	Screwdriver

---

## DRONE'S DETAILS

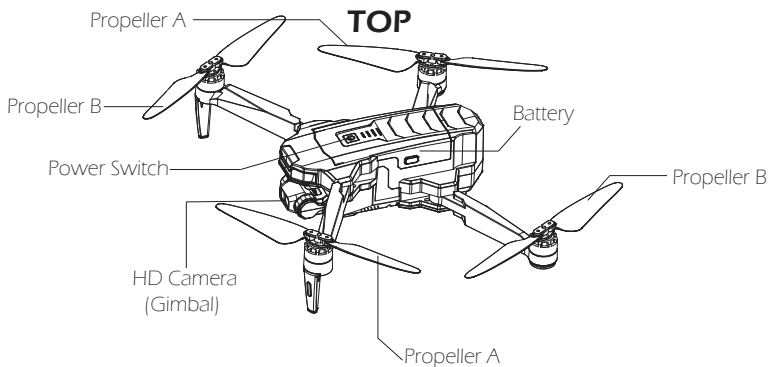

## BOTTOM

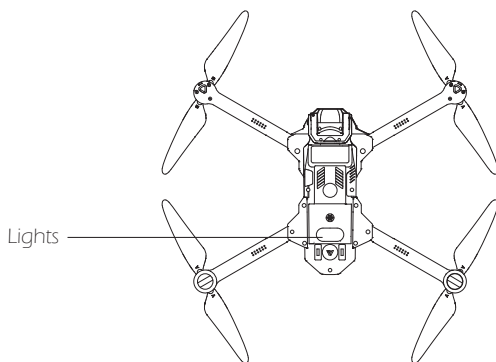

---

# CONTROLLER DETAILS

## Controller Functions

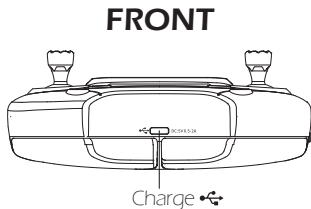
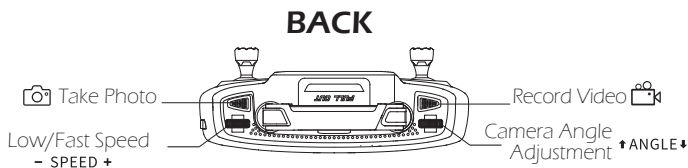
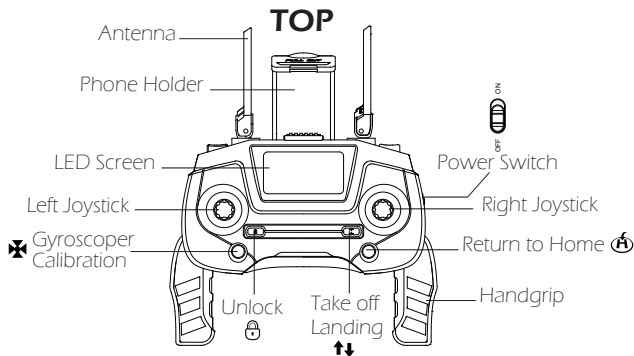



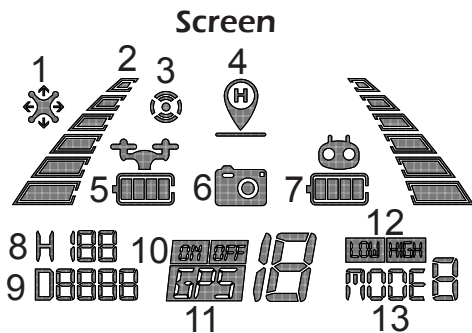

1. Gyroscope calibration
2. Flight signal
3. Compass calibration
4. Return to home
5. Drone battery energy
6. Take photo/video
7. Controller battery energy
8. Height
9. Distance
10. GPS status
11. GPS signal
12. Low/Fast speed
13. Throttle switch (Mode 1 left throttle/Mode 2 right throttle)

### • Left/Right Throttle Swift

The controller defaults the left throttle.

To switch it to the right throttle, turn off the controller, then, long press the 'Ⓜ' button and turn on the controller at the same time. 'MODE 2' showing on the LED screen means it switched successfully.

If need to change back to left throttle, just reboot the controller.

---

### • GPS Mode Switch

When turning on the controller, the default mode is the GPS Mode. Check the icon on the controller screen to confirm GPS status.

### • Return to Home

Press the button to start the RTH. The controller emits a “beep-beep” sound every 1.5 seconds as the drone flies back to the recorded Home Point.

Press the RTH button again to exit RTH procedure and regain control of the drone.

### • Unlock/Lock

Press the button “” then the motor will rotate.

Press the red button “” again, the motor will stop rotating and the drone will be locked.

### • Photo/Video

Press the camera button  on the Controller, the camera takes one photo.

Press the same video button  on the Controller, the camera will take the video. Press again to exit shooting.

### • Speed Switch

Low speed is the default setting.

Push the gear “ - SPEED + ” to right on the Controller and you will hear a “beep”, indicating the drone is at low speed.

Push the gear “ - SPEED + ” to left and you will hear two beeps, indicating the drone is at high speed.

---

# Controller Operation

## Left throttle

### Left Joystick

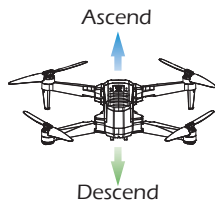
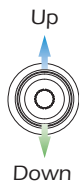

---

### Right Joystick

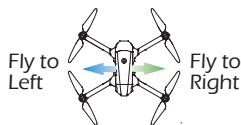
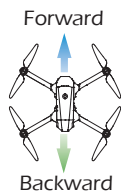
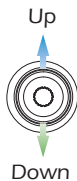

---

## Controller Operation

### Right throttle

#### Left Joystick

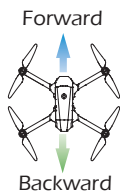
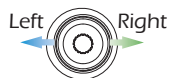
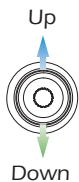

---

#### Right Joystick

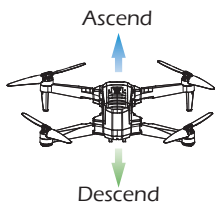
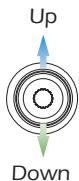

---

## INSTALLATION

### Drone Battery

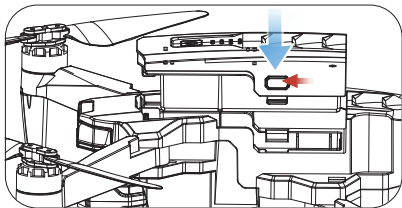

**Installation:** Push the battery into the battery compartment of the drone. Make sure it “clicks” into place indicating the battery is firmly installed.

**Attention:**

The battery should be installed firmly. Failure to do so may affect the flight safety of your drone. The drone may crash due to a power-cut during flight.

---

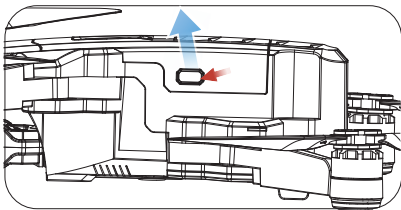

**Removal:** As shown above, press and hold the locks on both sides of the battery at the same time to remove the battery.

## Installing TF Card

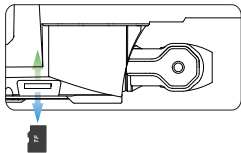

As shown in the above figure, please insert the TF card (**needs to be purchased separately**) into the TF card slot. A “click” signifies it is inserted correctly. It will indicate memory card capacity in “SD Card testing ” of APP interface, that means the card was indentified.

- ! 1. Click the SD card testing will delete all contents in the SD card and cannot be recovered. Please be careful before confirmation.
- 2. The original pixel-sized pictures and videos will be stored on the TF card.

---

## Controller Battery

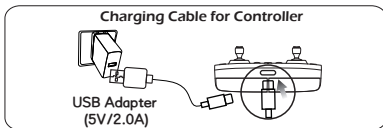

Low battery warning

When the controller battery energy icon  is flashing and controller handle emits a “beep” alarm sound every 3 seconds, indicating that the controller power is too low. The controller needs to be charged at this time.

**Tips: Please turn off the controller before charging.**

1. Connect the USB cable to a USB socket such as a mobile power supply.
2. Connect the controller with the USB cable and controller handle emits a “beep” sound. Flashing controller battery energy icon  indicates charging status. Charging is completed when the icon is solid.

! Notes:

1. **Charge only by USB cable of factory provided (Type C).**
2. Use a power supply with standard output voltage 5V and current greater than or equal to 2A, otherwise there is a risk of overloading the USB cable and battery. A full charge takes approximately 90 minutes.

---

## Propellers

### Installation

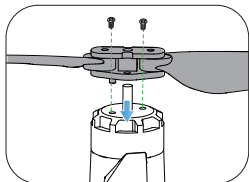
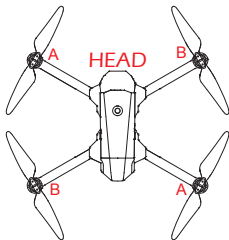

The drone will not fly unless the correct propeller is installed on the correct motor shaft. See illustration above. An "A" or "B" is printed on the back of each propeller. Lock the propeller to the motor shafts with screws rotating each screw clockwise.

---

### Removal

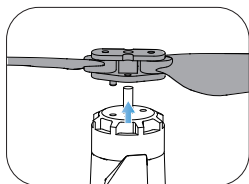
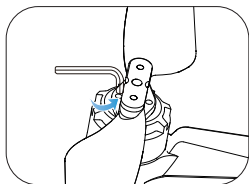

For propeller removal, use the screwdriver (provided) to rotate counter-clockwise and remove propellers.

---

## Phone Holder

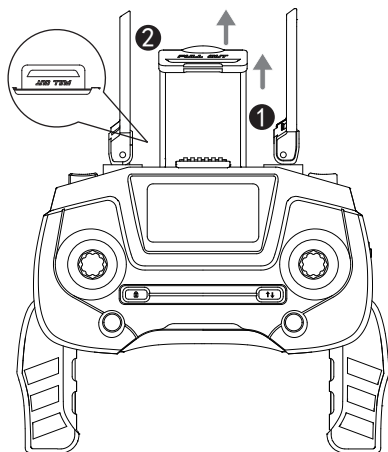

- ① Separate the Mobile Device Holder by pulling out **2** from **1** of controller.
- ② Adjust the Mobile Device Holder for a tight grasp of your phone.



---

## CHARGING

### Charging Cable for Drone Battery

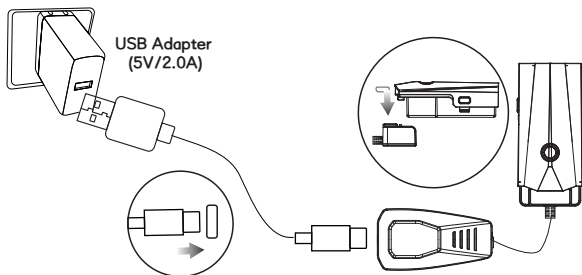

① Connect the USB cable to a USB socket such as a mobile power supply **(Use a power supply with standard output voltage 5V and current greater than or equal to 2A, otherwise there is a risk of overloading the USB cable and battery)**. Connect the charger with the USB cable, and then connect the battery with the charger. The charger's LEDs begin flashing. When all four LEDs become solid, full charging is completed.

② The charging time of a single battery is 4~6 hours.

- !** 1. **Charge only by USB cable of factory provided (Type C).**  
2. Before charging, please carefully review the **"Use of Battery"** section contained in **"SAFETY GUIDELINES"**.

---

## OPERATION GUIDE

### Downloading App



Google play

**Scan the QR code, corresponding to either App Store™ or Google™ Play Store and download the “Attop View” application for free.**

Required Operating Systems: iOS v8.0 and later / Android v4.3 and later

**Tip: Please use a smartphone that can support receiving 2.4G and 5G WiFi signals.**

### Unfolding the Drone



To unfold the drone by following the steps below.

Step 1: Unfold the front arms.

Step 2: Unfold the rear arms and place the drone on a flat, level surface.  
Head should face forward.

## CONTACT US

**Please do not hesitate to contact us if you need further support.**

**Customer Service Email: [attop@afterservice.vip](mailto:attop@afterservice.vip)**

## Pairing

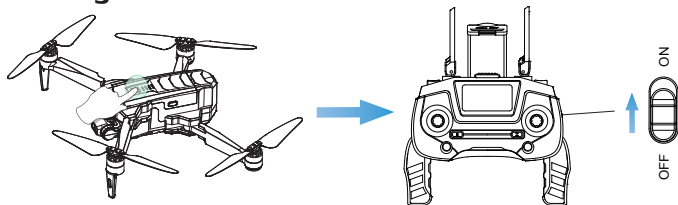

- ① First, press the drone Power Switch and quickly release. Then, press again and hold for approximately 2 seconds. The drone will emit a sound and the battery LEDs will brightly illuminate indicating it is now powered up. Place the drone on a flat, level surface with the head facing forward.
- ② Turn on the switch on the controller by sliding it to the top. Once the controller emits "beep-beep" sound, it confirms that the drone and controller are now successfully paired.

- ! 1. If pairing fails, please restart the drone, press and hold the button  and then turn on the power of controller.**
- 2. Please operate pairing between drone and controller before connecting WiFi signal.**

## Connecting to Wi-Fi

- ① Connect your smart phone to the Wi-Fi network created by the drone. Check the drone's status in the "**Attoview**"  app.
- ② Your smartphone will launch a search of the available Wi-Fi networks:

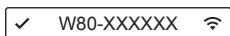

- ③ Select the Wi-Fi network: **W80-XXXXXX**
- ④ Wait for several seconds until your smartphone connects to the drone's Wi-Fi network.

**This connection is generally represented by the Wi-Fi logo appearing on your smartphone's screen.**

⑤ Launch the **Attop View** application.

> The connection between your smartphone and the drone will be established automatically.

## Calibrating the Compass

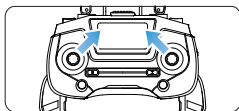

### Attentions:

- Push Left Stick to top right corner and Right Stick to top left corner simultaneously to activate Compass calibration (Pic), when operate the drone and app at first time.
- Compass calibration will be activated automatically after rebooting 30 times.
- Retrun the drone when the app warns **“Geomagnetic anomaly, please leave the source of interference and recalibrate the compass!”**.

Please move to open space without interference to operate the drone. Push left stick to top right corner, right stick to top left corner simultaneously for activate compass calibration.

After successful pairing, the drone LED lights flash rapidly. You can now begin compass calibration.

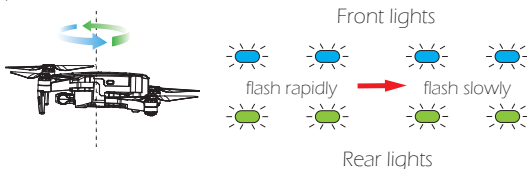

### Step 1:

Now, the app interface displays the above diagram and the Compass calibration icon  in controller screen is flashing. Hold the drone horizontally and rotate the drone in approximately 3 complete circles. When completed, the controller emits a “beep” sound and the drone’s LED lights flash slowly.

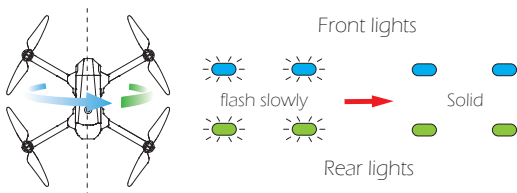

## Step 2:

Now, the app interface displays the diagram. Hold the drone vertically and rotate the drone in 3 complete circles. When completed, the controller emits a “beep” sound and the drone’s LED lights become solid and the Compass calibration icon  in controller screen is solid on.



## Attentions:

- Now the Gimbal is detecting for roughly 10 seconds. Please do not touch the Gimbal.
- Horizontal calibration is carried out after compass calibration.
- Searching GPS signal after horizontal calibration completed, indicates “**GPS signal searching.....**” in the app interface, please wait patiently.
- When it indicates “**Equipment connected (GPS Mode)**” and “**Ready to Fly**” in the app interface, it means that the drone receives the GPS signal. Now, the rear LED’s of the drone will flash twice per second.

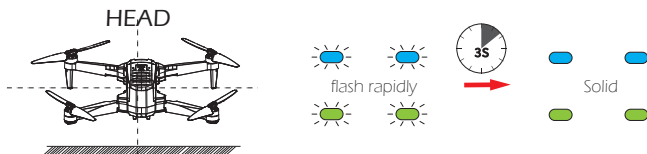
## Horizontal Calibration



---

Now, the app interface displays the diagram. Place the drone on a flat level surface and  **Slide right to confirm** . The LED lights of the drone will flash rapidly for about **3 seconds**. When completed, the front and rear lights turn solid. Or press the Gyroscope calibration switch “  ” on the controller. The LED lights of the drone will flash rapidly for about **3 seconds**. When completed, the front and rear lights turn solid.

---

## Unlocking the Motor

**Please unlock the motor before take-off.**

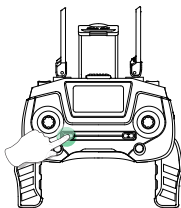

 Press the button “  ”, the motors rotate.

① Unlocking the motor

Please unlock the motor while it indicates “**Equipment connected (GPS Mode)**” and “**Ready to Fly**” in the app interface.

② If you do not perform any operation approximately 10 seconds after unlocking the drone, the motors will stop rotating.

## Locking the Motor

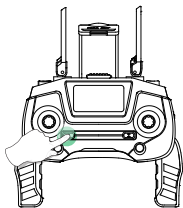



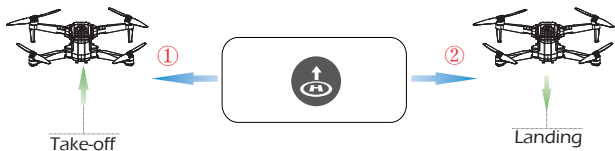

Pic. 1

Press the button “” again, the motor will stop rotating and the drone will be locked. (Pic. 1)

## One Key Take-off/Landing



① After unlocking the drone, press the “” button on the controller and the drone will automatically take off and hover at 1.5m altitude. Or press the “” in the app interface, then “ Slide right to confirm ” after unlocking the motors.

② When the drone is flying, press the “” button on the controller, the drone will fly back to the Home Point and automatically land on the ground.

### Tip:

**Before flying, make sure the GPS Mode is activated in case the drone gets lost!**

---

## FUNCTION DETAILS

### Camera Angle Adjustment

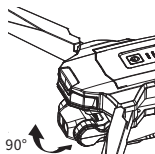
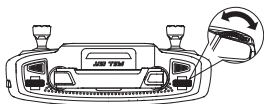

During flight, you can dial the wheel left/right to tilt the camera up/down. (The gimbal has a 90° tilt range.)



**Please do not touch the camera gimbal directly.  
Doing so may cause damage!**



## Low Voltage RTH

① When the drone's lights flash slowly, the “” symbol is displayed in the controller screen. Then the First Low Voltage RTH will be triggered. The controller will emit “beep-beep” alert every 6 seconds. The drone will return automatically in the following two conditions: **(At this time, the drone can only fly within a safe range of its height no more than 20m and its distance no more than 30m.)**

a. When the flight distance is more than 30m, the drone will fly automatically into the electronic fence (**H 20m x D 30m**) and stay the current distance, then exit the First Low Voltage RTH. If the flight distance is equal to 30m, the drone will stay current distance, then exit the First Low Voltage RTH.

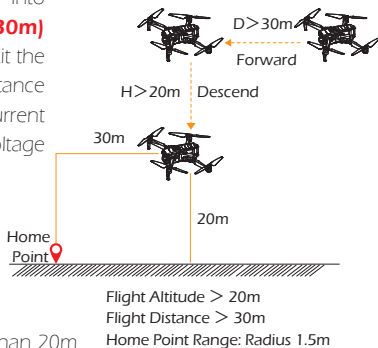

b. When the flight altitude is higher than 20m, the drone maintains its current height and then flies automatically into the electronic fence (**H 20m x D 30m**), then exit the First Low Voltage RTH. If the flight altitude is lower than 20m, the drone will ascend to 20m and fly automatically into the electronic fence (**H 20m x D 30m**), then exit the First Low Voltage RTH.

---

② If the drone's lights begin to flash rapidly the “” symbol will be displayed in the controller screen and the controller will emit “beep-beep-beep” alert every 3 seconds. The Second Low Voltage RTH is automatically triggered. Drone will return automatically.

a. When the flight distance is 30m, the drone will fly automatically to Home Point and land on the ground. If flight distance is less than 5m, the drone will maintain its distance and then land on the ground.

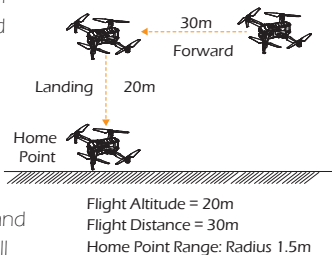

b. When the flight altitude is equal to 20m and the distance is more than 5m, the drone will maintain its current altitude, fly automatically to Home Point and then land on the ground. If the flight altitude is lower than 20m and the distance is more than 5m, the drone will ascend to 20m and fly automatically to the Home Point, and then land on the ground.

- !** **1. During the Second Low Voltage RTH, the drone can not be controlled to ascend and descend. But you could operate the Right Joystick to change the landing position (adjustment range 10 meters).**
- 2. The drone cannot avoid obstacles.**

# APP OPERATION INSTRUCTION

## Operation Interface



3D VR



Waypoint flight



Follow me



Surrounding



Lock



Find drone



Music



Home page



Flying record



Drone signal



Satellite



Battery



Setting



Take off



Landing



Return



Function



SD Card testing



Photo



Shutter button



Video



Filter



Zoom





Media

H.N/A D.N/A V.S.N/A H.S.N/A

Flight data

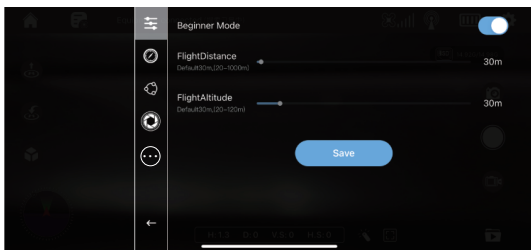
## Setting Parameters



Click the “” icon to enter the setting interface (as shown in the figure above). You can set a limited flight range:

1. Maximum flight distance: 66~3281 ft / 20~1000 m.
2. Maximum flight altitude: 66~394 ft / 20~120 m.
3. Maximum flight radius: 16~164 ft / 5~50 m. (The Point of Interest's flight radius is set at 16 ft by default.)
4. Beginner Mode (default setting): The default flight altitude is 98 ft / 30 m.  
The default flight distance is 98 ft / 30 m.

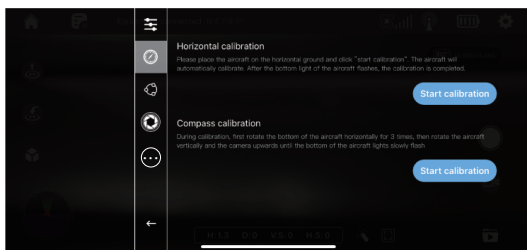

You can also start calibration of the Gyroscope and Compass in the setting interface (as shown above).

---

## Follow Me

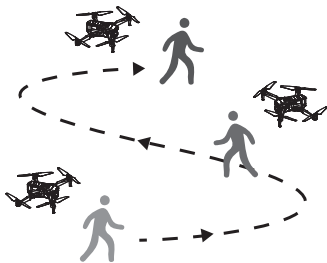

When the Follow Me function is enabled, the drone will follow the GPS in your smart phone to follow you wherever you go.

1. Ensure the drone's flight range is within 30m.
2. Click the "📍" icon on the app interface, then click "👤" to enter the Follow Me function. Next "👉 Slide right to confirm" the drone will now follow the phone's coordinates.
3. To exit Follow Me Mode, simply click the "👤" icon on the app interface again.

### Common Issues :







- ① Follow Me mode may be difficult to activate if the phone's GPS signal is too weak. This could be due to the signal loss from surrounding buildings, trees, or congestion from too many mobile phones in the area.
- ② Use in an open area and be mindful of your surroundings. The drone is NOT equipped with obstacle avoidance.

---

## Waypoint Flight

It is recommended to enlarge the map if you want to use Waypoint.







1. Click the “” icon on the app interface, then click “” to enter the Waypoint flight function.
2. Draw a line on the map to create a path (maximum 15 paths). Click “” icon to submit the route, then “ Slide right to confirm”. The drone will now fly along the path according to the points connected on the map.
3. Click the “” icon to deduct the path.
4. Click the “” icon to delete all paths to stop waypoint flight.
5. Exit the Waypoint flight mode by clicking the live transmission image .
6. If the flight path submission fails, you can choose to re-submit or exit again.
7. The drone will fly back to the starting point after executing flight path.

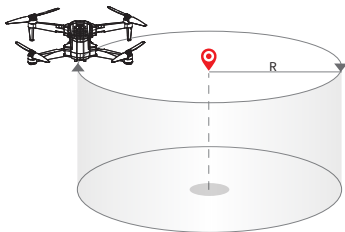

- **DO NOT fly the drone towards people, animals, or small/ fine objects (e.g. tree branches and power lines) or transparent objects (e.g. glass or water).**
- **There may be some deviation between the expected and actual flight path.**

## Point of Interest

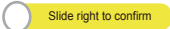



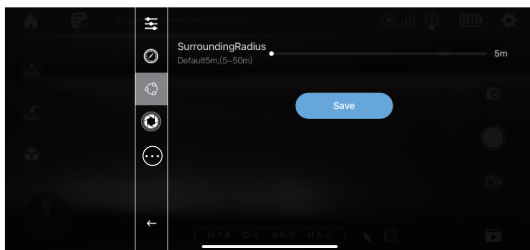



1. Click the “” icon on the app interface. Click “” then “” to enter the Point of Interest function.
2. The drone will record its flight position the moment while you enter this function of the Point of Interest. The drone will now continuously circle clockwise around the preset point. (The default radius is 5m. To change the point, please click “Setting ” – “Flight Radius ” to reset.)

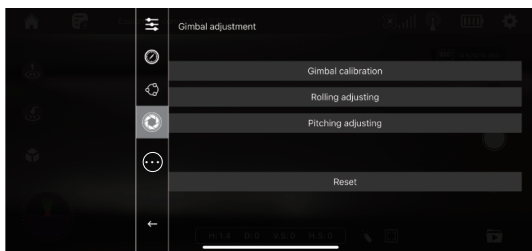

3. To exit Point of Interest mode, simply click the “” icon on the app interface again.

## Gimbal Adjustment



1. Put the drone on the surface ground and click the “” icon on the app interface and select the “”. Click ‘Gimbal calibration’, then the Gimbal starts detecting and calibrating automatically.
2. Click “Rolling adjusting” then click “ ” to adjust Gimbal rolling. (Pic.1)
3. Click “Pitching adjusting” then click “ ” to adjust Gimbal pitching. (Pic.2)
4. Click “Reset” to restore the default setting.



· Do not touch the Gimbal when it's in detecting.



(Pic.1)





(Pic.2)





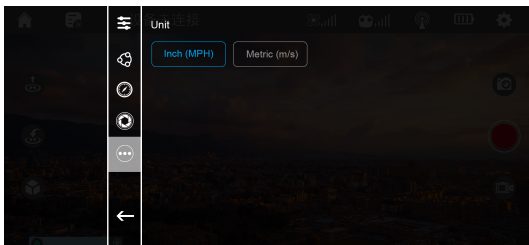

---

## Unit Conversion



1. Click the “Setting  ” icon on the app interface. Click “  ” then select the unit that you need.
2. “Metric (m/s)” is the default unit.

## Take Photo/Video

1. Click the “   ” icon to switch between photo and video mode.
2. When the shutter button is “  ”, click once to take a photo.
3. When the shutter button is “  ”, click once to start recording, and click again to stop recording.
4. Click the “  ” icon to enter the Media folder for viewing Photo and Video.







Pic 3

When the TF card is not installed, the photos or videos will be stored directly in the APP photo album (**Pic.3**) and smartphone.

**Tips: The app needs your access permission to phone album when first activating this function.**

When the TF card is installed, the photos or videos are stored in the TF card .







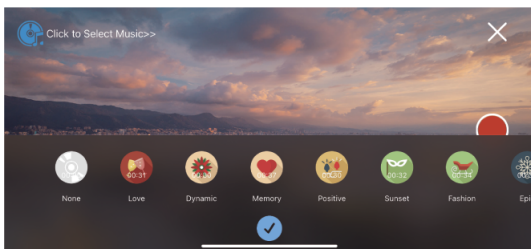







## Take Music Video

Click the “” icon on the app interface, then click “” and then click “Click to Select Music”. Click “” after selecting the music you prefer. And click “” to recording video.

The music video is saved in the app and phone Gallery.



## DRONE STATUS INDICATOR

Indicator Status	Meaning
  The drone's LED lights flash rapidly.	Drone is connected to the controller, Compass Horizontal Calibration begins.
  The drone's LED lights flash slowly.	Compass Horizontal Calibration has completed and begun Compass Vertically Calibration.
  Front lights turn solid blue, rear lights turn solid green.	Compass Calibration has completed. No GPS signal or weak GPS signal.
  Front lights turn solid blue, rear green lights flash twice per second.	Good GPS signal.
  Front and rear lights flash rapidly when pressing the calibration button.	Currently calibrate the Gyroscope.
  Front and rear lights flash slowly while flying.	The First Low Voltage RTH will be triggered.
  Front and rear lights flash rapidly while flying.	The Second Low Voltage RTH is automatically triggered.

---

## SPECIFICATIONS

### DRONE

Model: W80

Weight: 545 g / 19.22 oz

Max Flight Time: Approx 30 minutes

Operating Temperature Range: 32°F to 104°F

Dimensions: 115 x 175 x 80 mm (Folded)

285 x 225 x 80 mm (Unfolded)

### DRONE BATTERY

Capacity: 2500 mAh

Voltage: 11.4 V

Battery Type: Li-Po

Energy: 28.5 Wh

Charging Power: 34.2 W

Charging Temperature Range: 41°F to 104°F (5°C to 40°C)

Charging Time: 6 hours

### BATTERY CHARGER

Input: 5V  $\equiv$  2A (Type C)

Output: 11.4V  $\equiv$  1-2A

---

## CONTROLLER

Operating Frequency: 2.4 GHz

MAX Transmission Distance: 1000m (outdoor and unobstructed)

Battery: 3.7V 500 mAh.

Charging Time: Approx. 90 mins

Operating Temperature Range: 32°F to 104°F

## CAMERA

Camera frequency: 5 GHz

Resolution: 4K

Lens: FOV 90°

FPV Distance: 800m (outdoor and unobstructed)

Photo: JPEG

Video: MP4

MAX Supported TF Cards: 128 GB (Not included)

Controllable Range: Pitch: -90° to 0°

Operating Temperature Range: 32°F to 104°F

## USB CHARGING CABLE

Voltage: 5 V

Ampere: > 2 A

---

## TROUBLESHOOTING

No.	Problem	Solution
1	When the drone is powered on, the indicator light keeps flashing rapidly.	The drone is in the Gyroscope Calibration Mode. Please place the drone on a flat, level surface.
2	The drone cannot hover after takeoff and tilts to one side.	Place the drone on a flat, level surface and repeat Gyroscope Calibration.
3	The drone vibrated in flight.	A propeller may be damaged. Please inspect and replace any damaged propeller with a new one.
4	The drone could not be unlocked and the drone's lights flashed.	The drone battery voltage is too low. Please fully charge the battery.

## CONTACT US

**Please do not hesitate to contact us if you need further support.  
Customer Service Email: [atop@afterservice.vip](mailto:atop@afterservice.vip)**

---

## BATTERY WARNING:

1. Failure to follow all the instructions may result in serious injury, irreparable damage to the battery and may cause a fire, smoke or explosion.



2. Always check the battery's condition before charging or using it.

3. Replace the battery if it has been dropped, or in case of odor, overheating, discoloration, deformation or leakage.

4. Never use anything other than an approved Li-Po battery charger. Always use a balancing charger for LiPo cells or a Li-Po cell balancer.

5. The battery temperature must never exceed 60°C (140°F) otherwise the battery could be damaged or ignite.

6. Never charge battery on a flammable surface, near flammable products or inside a vehicle (preferably place the battery in a non-flammable and nonconductive container).

7. Never leave the battery unattended during the charging process. Never disassemble or modify the housing's wiring, or puncture the cells. Always ensure that the charger output voltage corresponds to the voltage of the battery. Do not short circuit the batteries.

8. Never expose the Li-Po battery to moisture or direct sunlight, or store it in a place where temperatures could exceed 60°C (such as car in the sun).

9. Always keep it out of reach of children.

10. Improper battery use may result in a fire, explosion or other hazard.

- 
11. Non-rechargeable batteries are not to be recharged. Rechargeable batteries are only to be charged under adult supervision.
  12. Different types of batteries or new and used batteries are not to be mixed.
  13. Batteries are to be inserted with the correct polarity.
  14. The supply terminals are not to be short-circuited. Regular examination of transformer or battery charger for any damage to their cord, plug, enclosure and other parts and they must not be used until the damage has been repaired.
  15. The packaging needs to be kept since it contains important information.
  16. The toy is only to be connected to Class II equipment bearing the symbol.



**Made in China**